



# *Presentación General*

# Rentametric

## *Atención Local en ...*

- **Belice**
- **Brasil**
- **Bolivia**
- **Chile**
- **Colombia**
- **Costa Rica**
- **Ecuador**
- **El Salvador**
- **Guatemala**
- **Guyana**
- **Honduras**
- **México**
- **Miami, FL (HQ)**
- **Nicaragua**
- **Panamá**
- **Perú**
- **República Dominicana**
- **Surinam**
- **Trinidad y Tobago**
- **Venezuela**

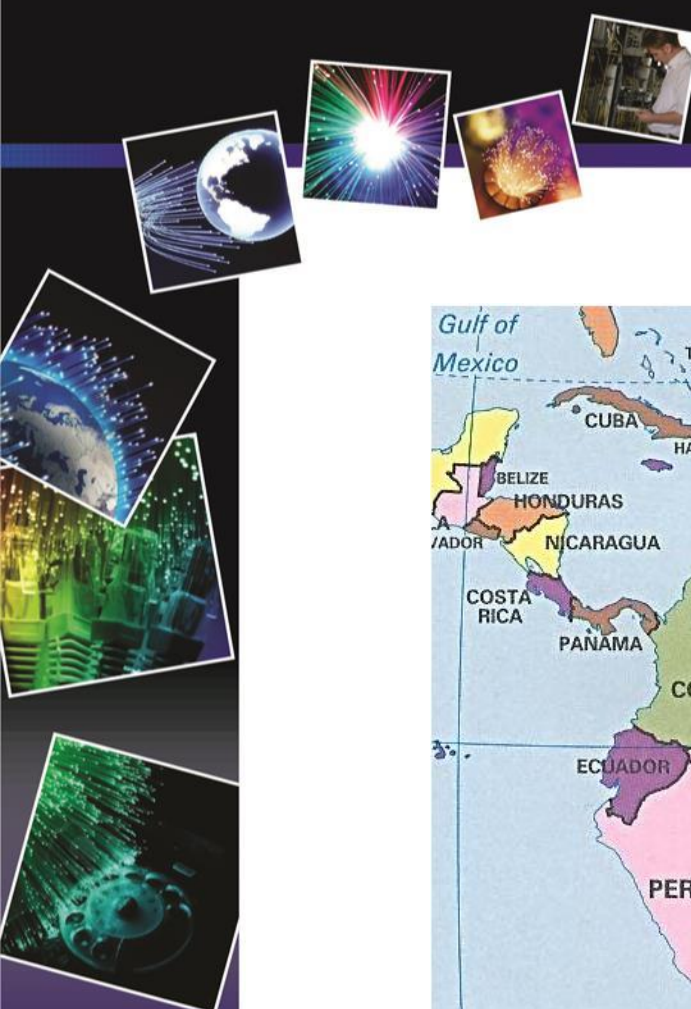

## Nuestros Socios Comerciales

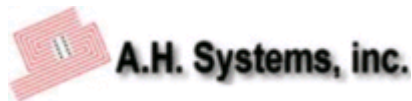



*Fibra Óptica y*

*FTTx*

*Pruebas e Inspección*

Rentametric

## *Fibra Óptica y FTTx - Pruebas e Inspección*

### Empalmadoras por Fusión



## *Fibra Óptica y FTTx - Pruebas e Inspección*

### Conectores Fusionables y Mecánicos



FAST Uni2



FuseConnect™

## *Fibra Óptica y FTTx - Pruebas e Inspección*

### OTDRs compactos y modulares



## *Fibra Óptica y FTTx - Pruebas e Inspección*

### Anillos de Fibra, Bobinas de Lanzamiento y Simuladores de Red

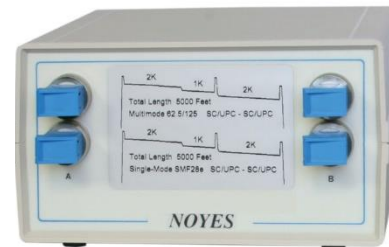



## Fibra Óptica y FTTx - Pruebas e Inspección

### Sistemas de Monitoreo Remoto

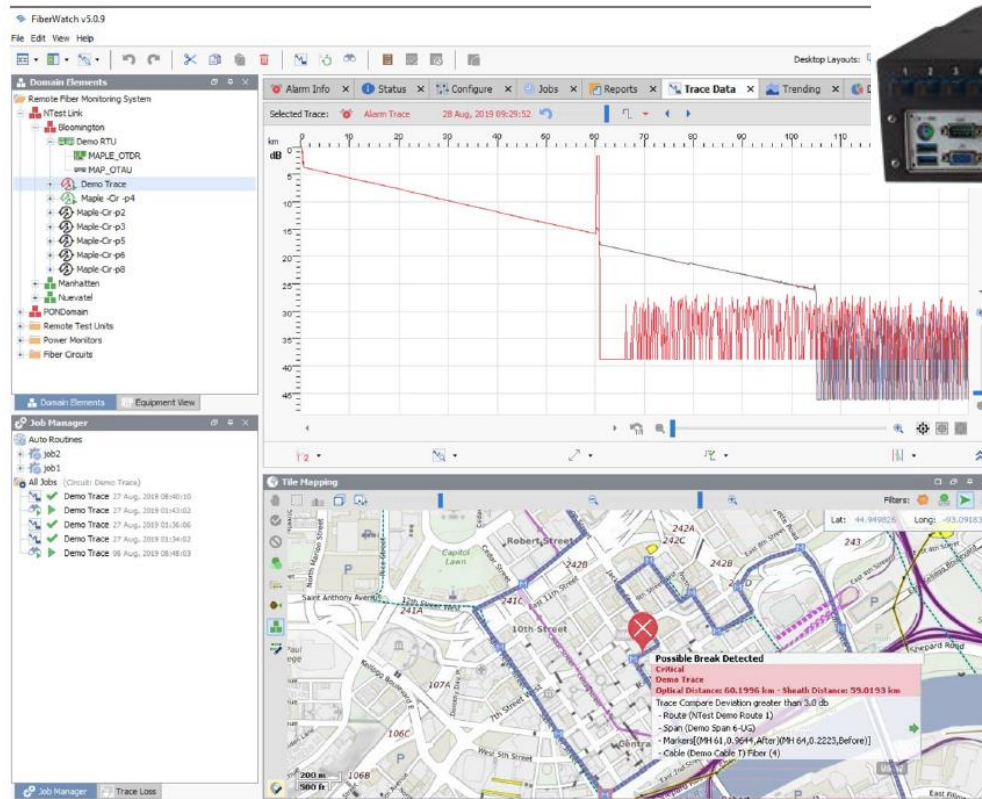

## *Fibra Óptica y FTTx - Pruebas e Inspección*

### Microscopios para Inspección de Conectores Ópticos



## Fibra Óptica y FTTx - Pruebas e Inspección

### Medidores de Potencia



## Fibra Óptica y FTTx - Pruebas e Inspección

### Fuentes Láser



## *Fibra Óptica y FTTx - Pruebas e Inspección*

### Localizadores Visual de Fallas (Luz Visible, VFL)



## *Fibra Óptica y FTTx - Pruebas e Inspección*

### Multiprobadores Ópticos y OLT



## *Fibra Óptica y FTTx - Pruebas e Inspección*

### Identificadores de Fibras



## *Fibra Óptica y FTTx - Pruebas e Inspección*

### Teléfonos Ópticos





## *Fibra Óptica y FTTx - Pruebas e Inspección*

### Simuladores FTTx PON

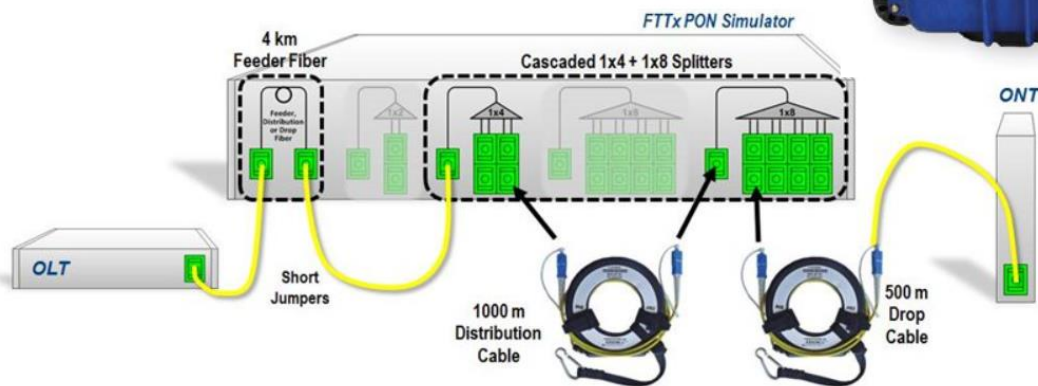

## Fibra Óptica y FTTx - Pruebas e Inspección

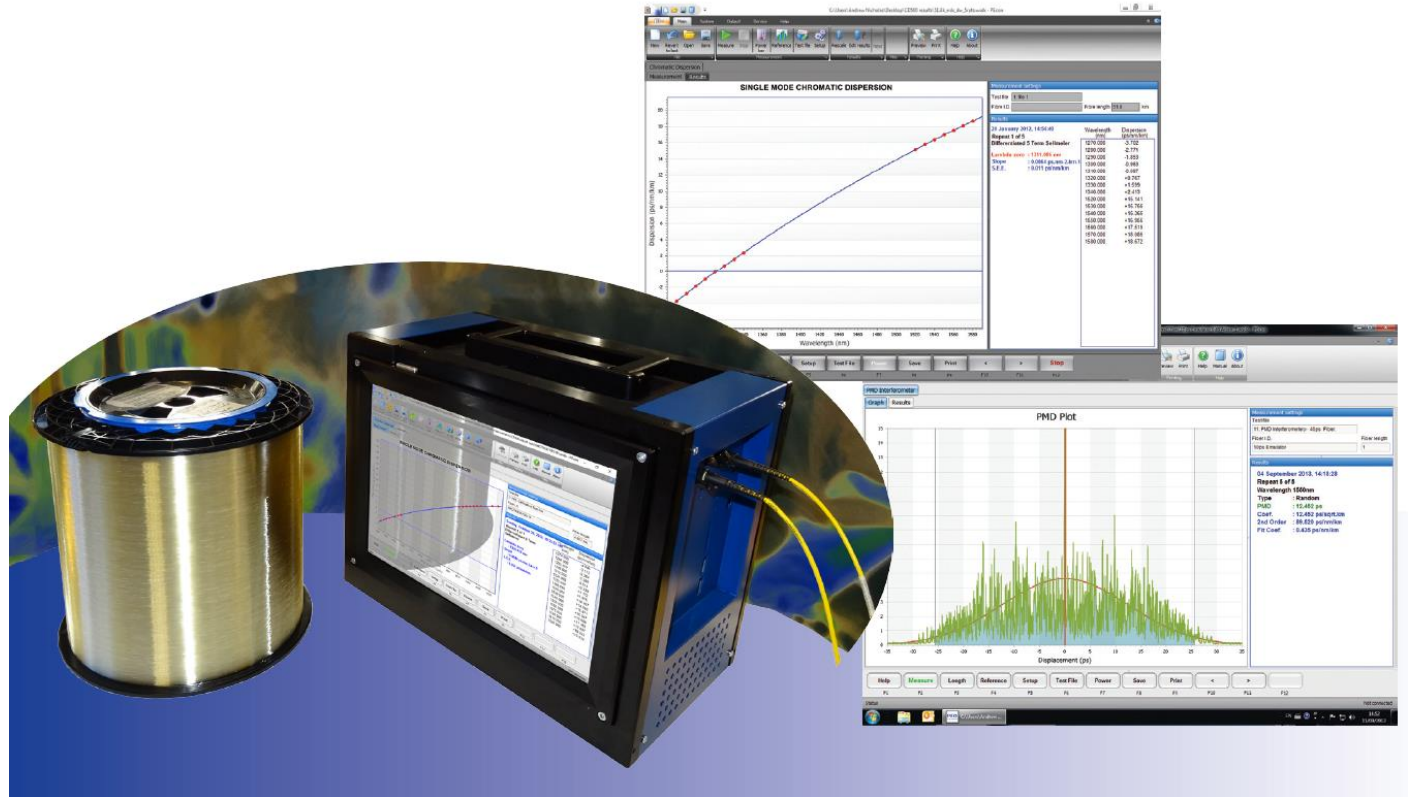

**Analizadores de PMD y CD**



*Fibra Óptica y FTTx - Pruebas e Inspección*

**Máquinas Tejedoras y Sopladoras**



## *Fibra Óptica y FTTx - Pruebas e Inspección*

### Herramientas y Kits para limpieza



## Fibra Óptica y FTTx - Pruebas e Inspección

### Consumibles

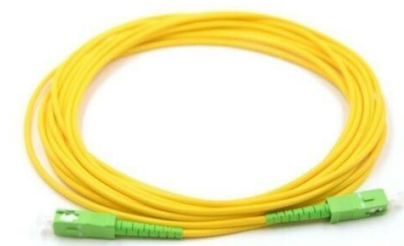
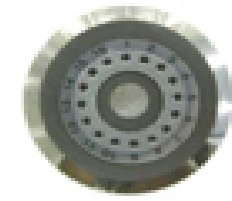

## *Fibra Óptica y FTTx - Pruebas e Inspección*

### Pasivos e Infraestructura

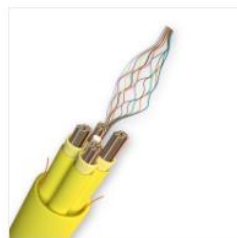
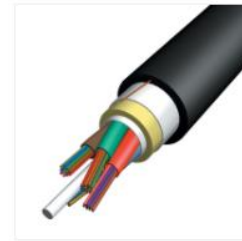



# *IT-Datacenter*

*Pruebas y Análisis*

# Rentametric



## *IT-Datacenter – Pruebas y Análisis*

### Certificadores de Redes LAN



## IT-Datacenter – Pruebas y Análisis

### Validación y pruebas de PoE

09/04/18 10:51 90%

PoE

Select Standard:

802.3bt (90W)

PSE Detected	Yes
Voltage	56.11 V
PSE Type	4
PD Class	8
PoE Cable Pairs	12-36, 45-78
Allocated Power	71.00 W

← ↻ ⚡



## *IT-Datacenter – Pruebas y Análisis*

### Probadores de Redes LAN

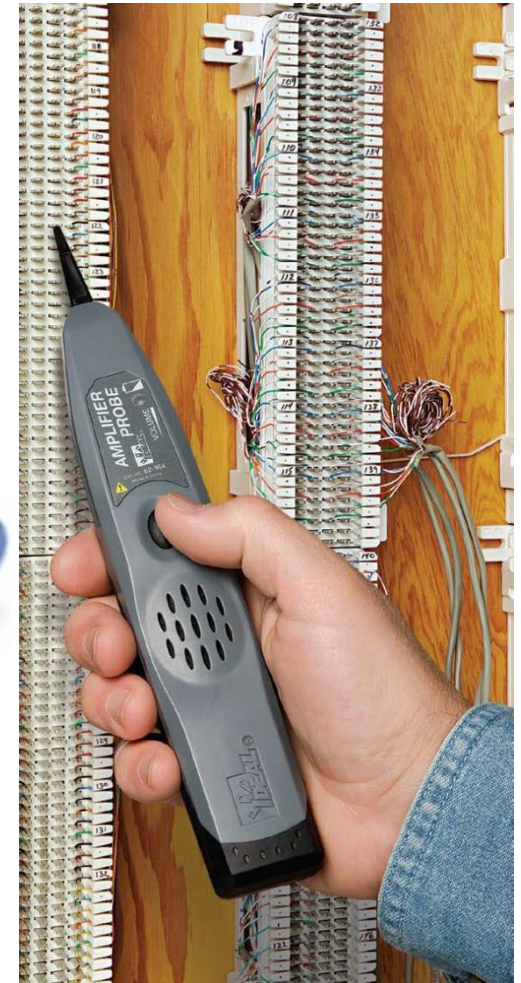

*IT-Datacenter – Pruebas y Análisis*

**Analizadores de Redes LAN y CCTV**



## IT-Datacenter – Pruebas y Análisis

### Certificadores Ópticos y OLTS



*IT-Datacenter – Pruebas y Análisis*

**OTDRs QUAD y Microscopios para Inspección en redes LAN**



## *IT-Datacenter – Pruebas y Análisis*

### Empalmadoras y Conectores Fusionables



FuseConnect™

## *IT-Datacenter – Pruebas y Análisis*

### Medidores de Tierras y Aislamiento





*IT-Datacenter – Pruebas y Análisis*

**Probadores de Bancos de Baterías**



## *IT-Datacenter – Pruebas y Análisis*

### Herramientas y Kits para limpieza



## *IT-Datacenter – Pruebas y Análisis*

### Pasivos e Infraestructura

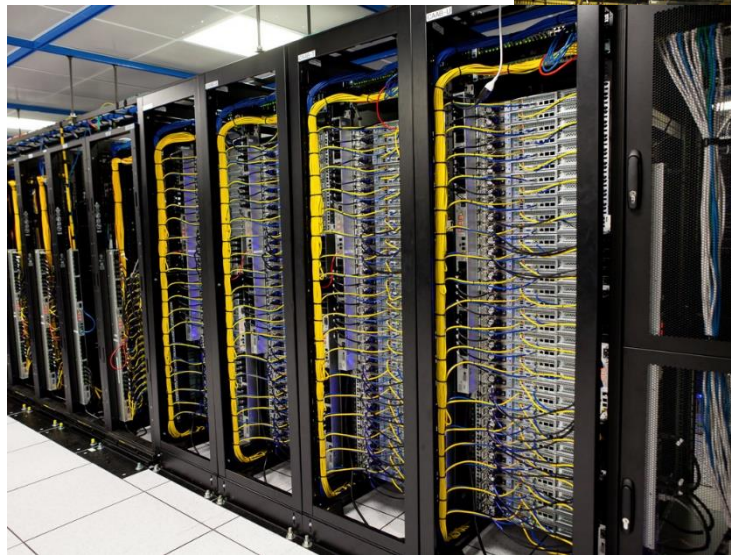



# *Transmisión*

*Pruebas y Análisis*

# Rentametric

*Transmisión – Pruebas y Análisis*

**Analizadores de BER para E1s / T1s**



## *Transmisión – Pruebas y Análisis*

### Analizadores para hasta 1 GbE



## *Transmisión – Pruebas y Análisis*

### Analizadores de Transmisión Multitecnología para hasta 100Gb



## Transmisión – Pruebas y Análisis

### Analizadores de Espectros Ópticos

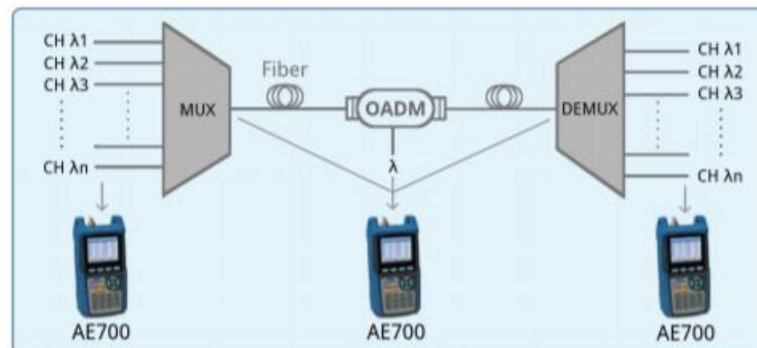



## Transmisión – Pruebas y Análisis



## Analizadores de Sincronismo

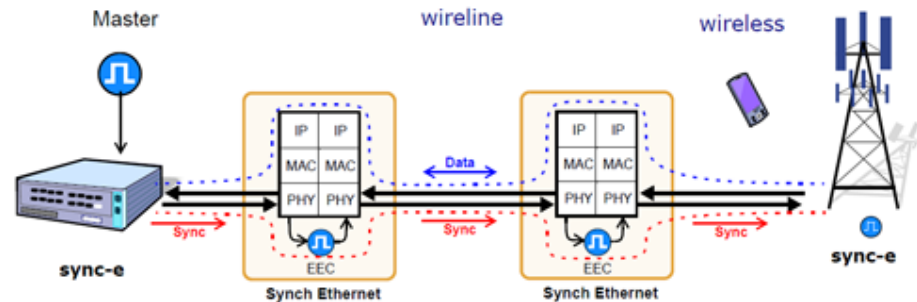

## *Transmisión – Pruebas y Análisis*

### Analizadores y Emuladores de Protocolos



## Transmisión – Pruebas y Análisis

### Pruebas de Carga y Estrés

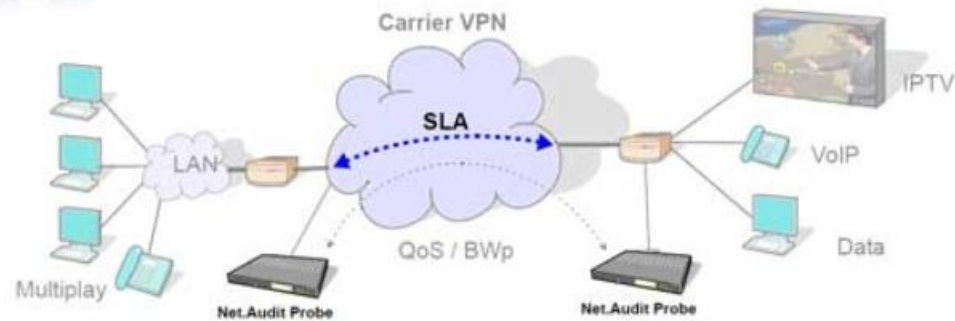

## Transmisión – Pruebas y Análisis

### Sistemas de Monitoreo y Gestión



PacketExpert™ 10GX mTOP™ Solution

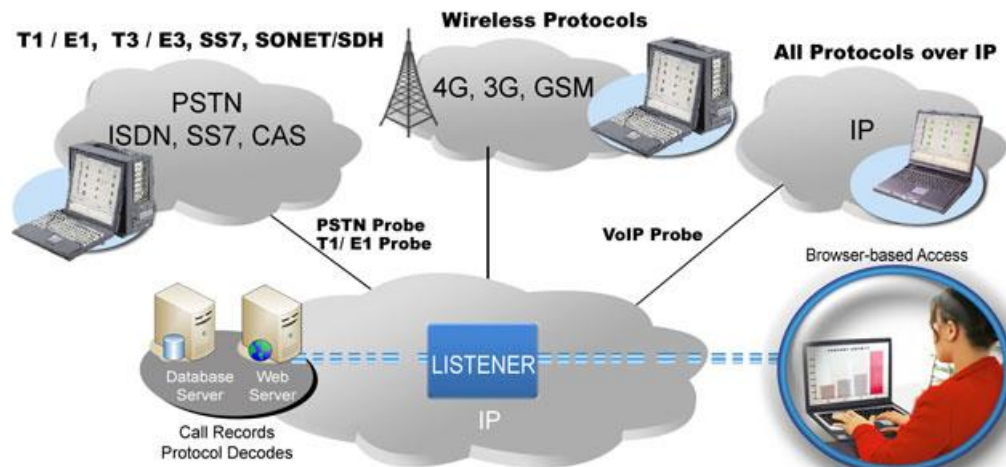

## Transmisión – Pruebas y Análisis

### Gestión de Calidad de Voz y Datos:

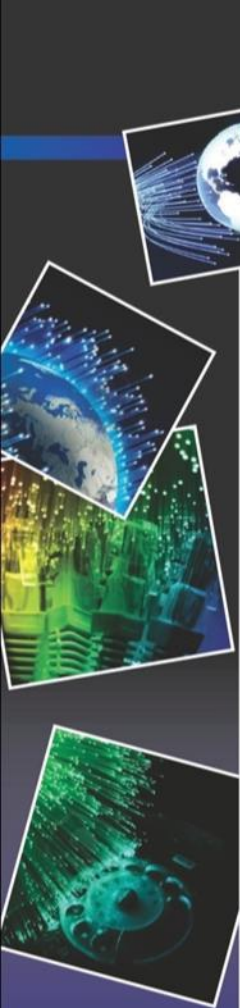
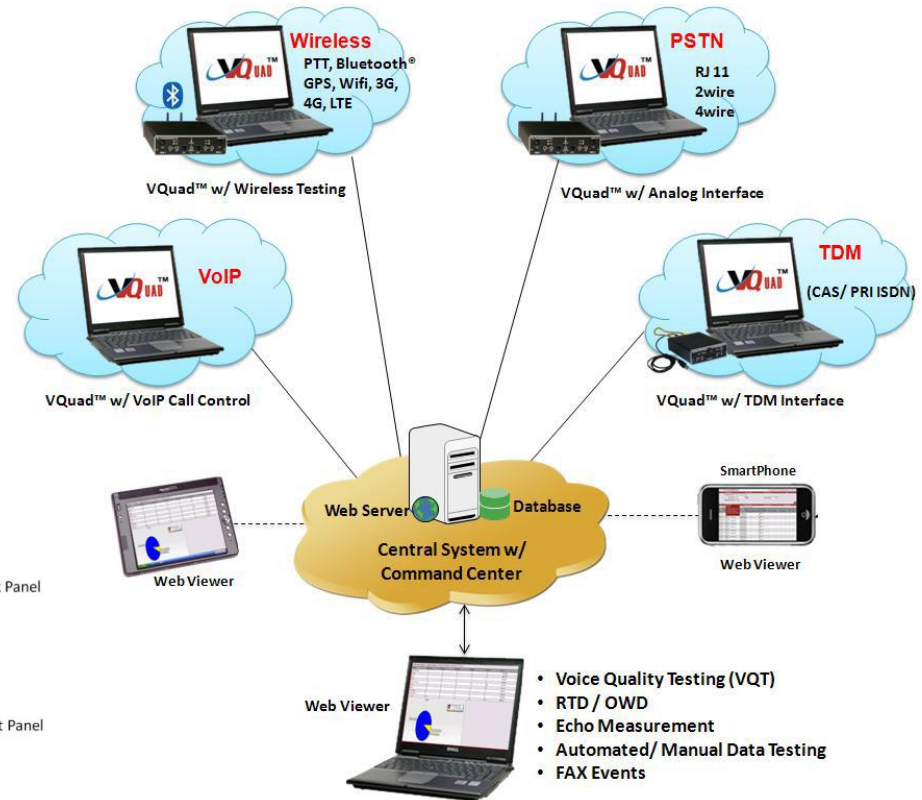



*Comunicaciones  
Inalámbricas  
Instalación y Mantenimiento*

Rentametric

*Comunicaciones Inalámbricas,  
Instalación y Mantenimiento*

Analizadores de Cable y Antena  
Analizadores de Celda



*Comunicaciones Inalámbricas,  
Instalación y Mantenimiento*

Caracterización y  
resolución de PIM



Conventional cell site

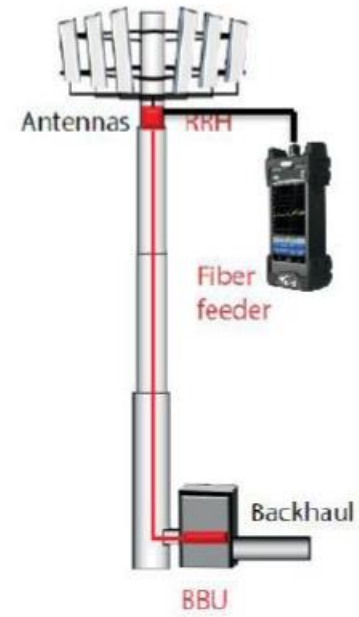

Distributed cell site



*Comunicaciones Inalámbricas,  
Instalación y Mantenimiento*  
**Analizadores de Espectros**

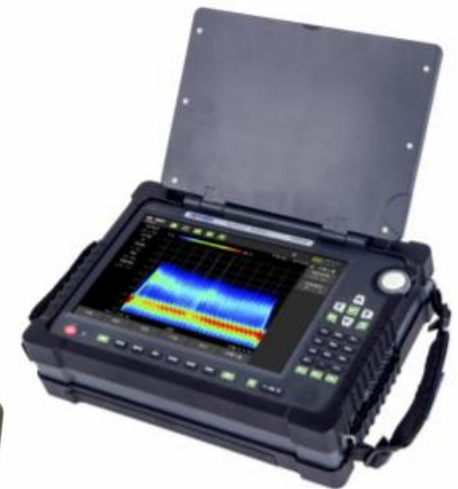

## Comunicaciones Inalámbricas, Instalación y Mantenimiento

### Mitigación de Interferencias



*Comunicaciones Inalámbricas,  
Instalación y Mantenimiento*

**Estudios de Sitio (Site Survey)**

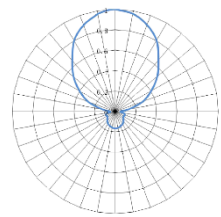

*Comunicaciones Inalámbricas,  
Instalación y Mantenimiento*

**Vatímetros para Mediciones  
de Potencia**



## Comunicaciones Inalámbricas, Instalación y Mantenimiento

### Drive Test / Walk Test



Automatic Post Processing of Report in Customized Format



Real time report to customer for Single Site Verification, Clusters and Shakedown



Real time Go No Go (GNG) from Customer before leaving the site



## Comunicaciones Inalámbricas, Instalación y Mantenimiento

### Instalación y Mantenimiento de WiFi



*Comunicaciones Inalámbricas,  
Instalación y Mantenimiento*

Mediciones de Backhaul  
y Sincronismo



*Comunicaciones Inalámbricas,  
Instalación y Mantenimiento*

Mediciones de Tierras y Aislamiento





*Comunicaciones Inalámbricas,  
Instalación y Mantenimiento*

**Probadores de Bancos  
de Baterías**





*CATV*

*Instalación y Mantenimiento*

Rentametric

## *CATV Instalación y Mantenimiento*

### Instalación y Mantenimiento en CATV/HFC/DOCSIS



## *CATV Instalación y Mantenimiento*

### Sistemas de Monitoreo en CATV/HFC

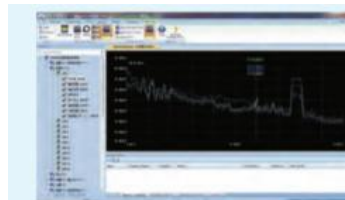

Real-time Monitoring



3D Monitor



Limit Lines Setup

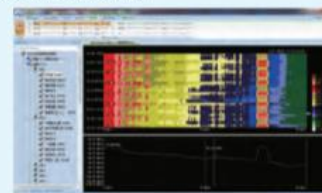

Spectrogram History



Video Timing

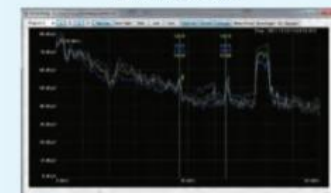

Video Replay

## *CATV Instalación y Mantenimiento*

### Mediciones en DTH Satelital



**DVBS/S2<sup>®</sup>**

## *CATV Instalación y Mantenimiento*

### Instalación y Mantenimiento de la Red Óptica



*CATV Instalación y Mantenimiento*

**Herramientas Especializadas para Coaxial y Fibra Óptica**





*Broadcast*  
*Pruebas en Radio y TV*

Rentametric



## Broadcast – Pruebas en Radio y TV

### Analizadores de TV



## Broadcast – Pruebas en Radio y TV

### Vatímetros Portátiles



## *Broadcast – Pruebas en Radio y TV*

### Vatímetros Fijos y Secciones de Línea



## *Broadcast – Pruebas en Radio y TV*



**Monitores de Potencia**

## Broadcast – Pruebas en Radio y TV

### Sistemas de Monitorización de Potencia en Canal



*Broadcast – Pruebas en Radio y TV*

Cargas Fantasma



*Broadcast – Pruebas en Radio y TV*

Atenuadores



## *Broadcast – Pruebas en Radio y TV*

### Sistemas de Monitorización de TV





## Broadcast – Pruebas en Radio y TV

### Analizadores de Espectros



## Broadcast – Pruebas en Radio y TV

### Supervisión del Espectro





*Servicios*

Rentametric

- Alquileres y Leasing de equipos
- Calibración de instrumentos con trazabilidad
- Ajustes de empalmadoras y cortadoras de precisión
- Reparaciones y garantías
- Capacitación virtual o en sitio





*¡Muchas Gracias!*

Rentametric